

H.V. Series Toggle Clamps

Swivel Base

Model No	HV-BII-500-TRIG
Weight	2.500 Kgs
Handle Opening ($\pm 3^\circ$)	65°
Clamp Bar Opening ($\pm 3^\circ$)	60°
Holding Capacity	11.80 kN
Material	Steel
Finish	Black ED* Coating
Arm Type	Solid Arm
Base Type	Swivel Base

Clamp is supplied in separate parts

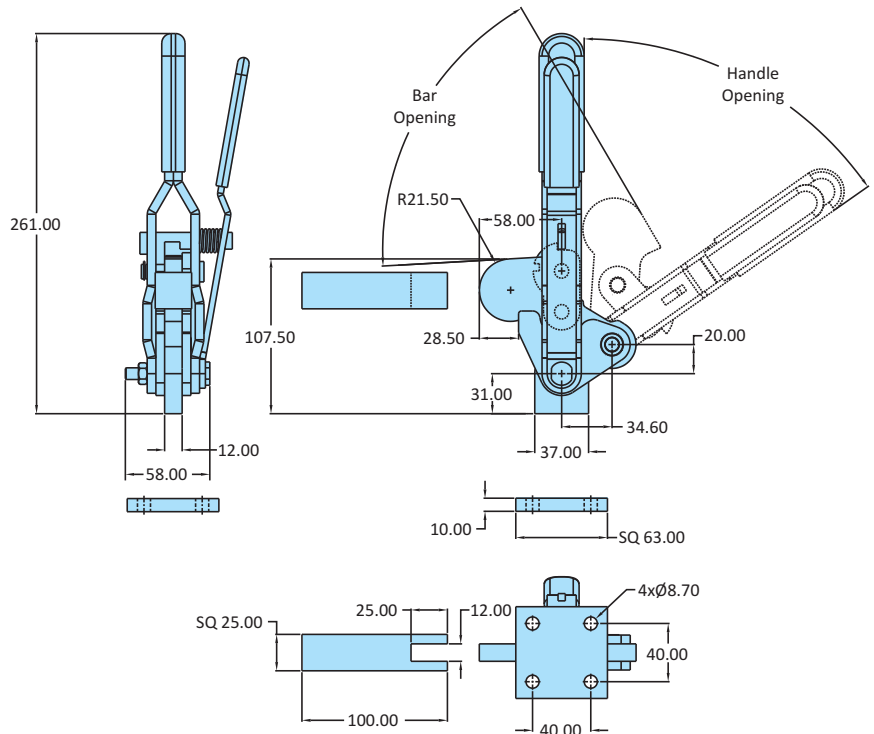
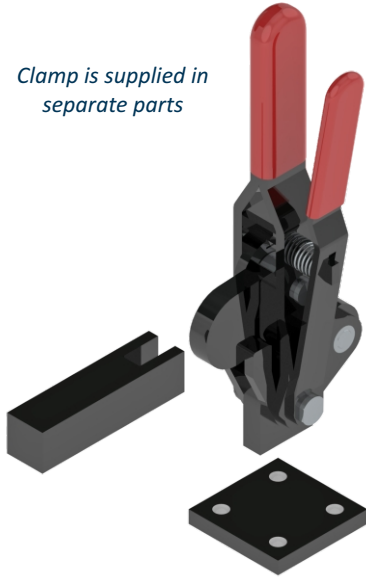

H.V. Series Toggle Clamps

Swivel Base

Model No	HV-BII-1000-TRIG
Weight	3.600 Kgs
Handle Opening ($\pm 3^\circ$)	71°
Clamp Bar Opening ($\pm 3^\circ$)	100°
Holding Capacity	24.50 kN
Material	Steel
Finish	Black ED* Coating
Arm Type	Solid Arm
Base Type	Swivel Base

Clamp is supplied in separate parts

